

Product Sheet Virgo+ LS2 LED module

Designed for the architectural lighting industry, the Virgo+ LS2 modules are part of the Virgolite™ modules family. For fast and easy installation the LED modules are inserted on one electrical conductor connected to the LED Master Power Supply (LMPS). The power Contactless LED technology eliminates electrical contacts and risks of corrosion.

Please refer to the Virgolite™ specification sheet and to technical bulletin #7 for all the complete information regarding this product.



Characteristics

Input Power	Only from the following Class 2 power supplies: LMPS-350 or LMPS-750
Dimming Option	Only with: LMPS-Dimmer Controller and LMPS-Dimmer Extender
Beam Angle	120°
LED Color Spectrum	White 3000K, 3500K, 6500K
Chromaticity Tolerance	3-Step MacAdam ellipse
Ambient Operating Temperature	-40° F to 122° F (-40° C to 50° C)
Operating Environment	Dry and damp locations (with LMPS-350 and LMPS-750), wet locations (only with LMPS-350)
Ingress Protection Rating	IP67
Warranty	5 years

Dimensions

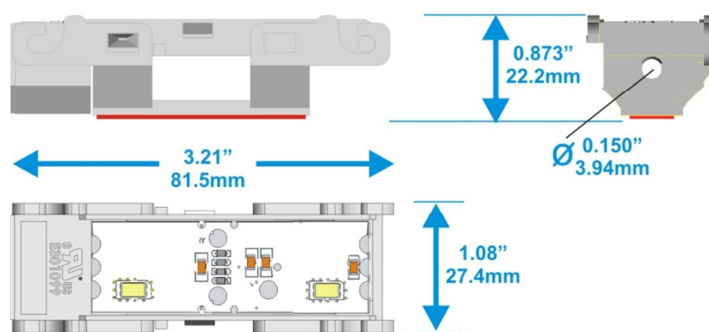

Loading Information

LEDs per module	Modules per foot	Consumption		Maximum number of modules	
		Watts per module	Watts per foot	White (3000K, 3500K, 6500K)	
				LMPS-350	LMPS-750
2	4 (12.8 inches)	0.8	3.2	43	93

Photometric Information **

Lumens per modules			Lumens per foot*			Lumens per watt			CRI		
3000K	3500K	6500K	3000K	3500K	6500K	3000K	3500K	6500K	3000K	3500K	6500K
73	77	81	293	308	323	91	96	101	85	85	84

* All values are for the maximum allowable number of modules per foot / ** Photometric data is subject to change, LM-79 data & IES files are available for 3500K modules.

Ordering Information

Product	Product number
Virgo+ LS2 3000K	VI-V2-2-30K
Virgo+ LS2 3500K	VI-V2-2-35K
Virgo+ LS2 6500K	VI-V2-2-65K

Specifications are subject to change without notice.

© HEICO lighting™ 2014 – All rights reserved. Made in Canada.

HEICO lighting™
400 du Parc, Saint-Eustache
Québec, Canada, J7R 0A1
+ 1.800.665.1166
www.heicolighting.com